

QUICK INSTALLATION GUIDE

HARDENED UNMANAGED SWITCH

Front Panel

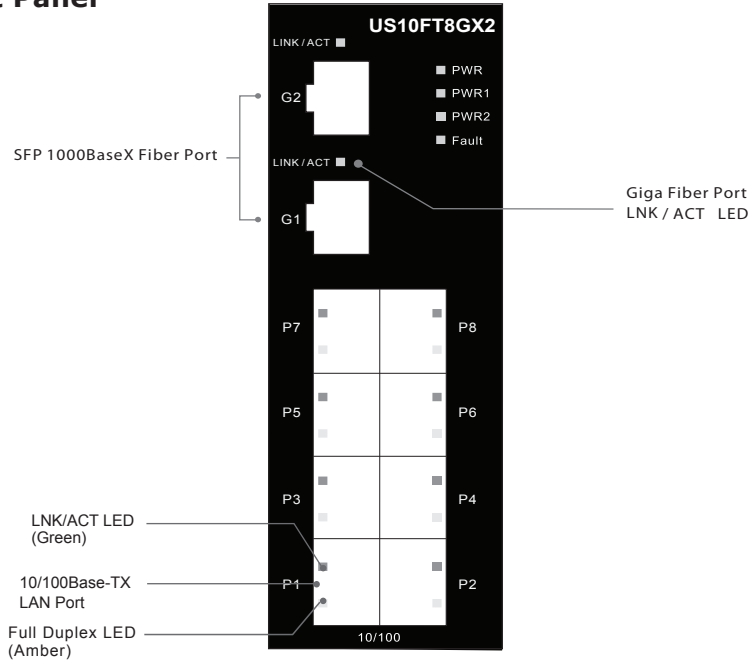

Installation

DIN-Rail Install Step

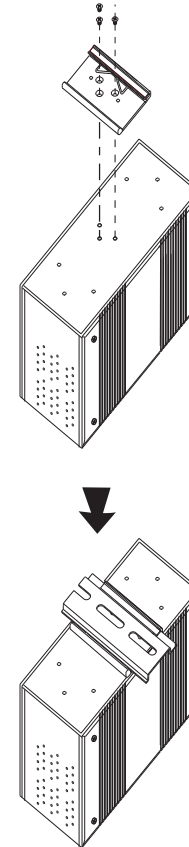

Wall-mounted Install Step

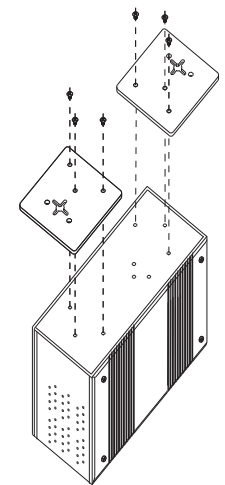

Power Connection Guide

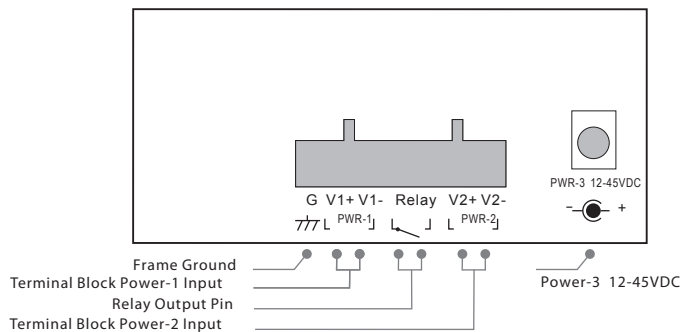

QUICK INSTALLATION GUIDE

HARDENED UNMANAGED SWITCH

Accessory

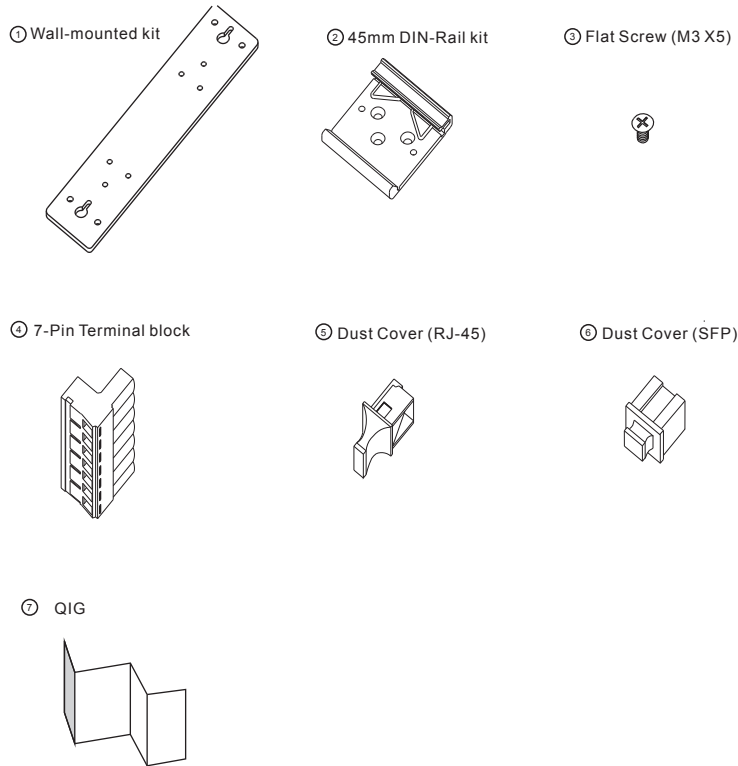

Packing list

Model name	Model Description	Accessory
US10FT8GX2	Industrial 10-port unmanaged Ethernet switch with 8x10/100Base-T(X) and 2x1000Base-X, SFP socket	⊗X 1, ⊗X 1, ⊗X 6, ⊗X 1, ⊗X 8, ⊗X 2, ⊗X 1

Communication Connections

10/100BaseTX Ethernet Port Connection

- RJ45 (8-pin,MDI) Port Pinouts
- RJ45 (8-pin,MDI-X) Port Pinouts

Pin	Single	Pin	Single
1	Tx+	1	Rx+
2	Tx-	2	Rx-
3	Rx+	3	Tx+
6	Rx-	6	Tx-

1000Base T Ethernet Port Connection

- RJ45 (8-pin,MDI) Port Pinouts
- RJ45 (8-pin,MDI-X) Port Pinouts

Pin	MDI	Pin	MDI-X
1	BL_DA+	1	BL_DB+
2	BL_DA-	2	BL_DB-
3	BL_DB+	3	BL_DA+
4	BL_DC+	4	BL_DD+
5	BL_DC-	5	BL_DD-
6	BL_DB-	6	BL_DA-
7	BL_DD+	7	BL_DC+
8	BL_DD-	8	BL_DC-

- RJ45 (8-pin) to RJ45(8-Pin) Straight-Through Cable Wiring

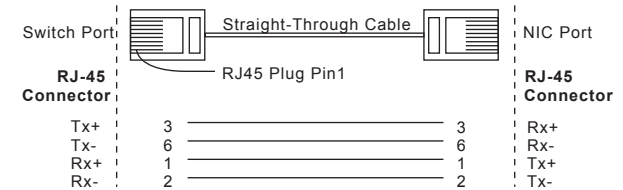

- RJ45 (8-pin) to RJ45(8-Pin) Cross-Over Cable Wiring

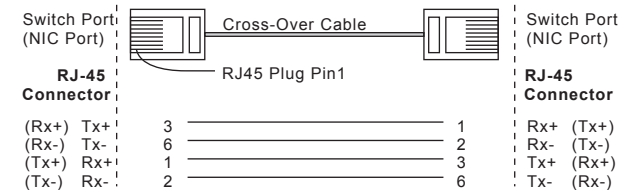

1000Base-X SFP Port Connection

